



**TEST REPORT
IEC 62133-2**

**Secondary cells and batteries containing alkaline or other non-acid electrolytes – Safety requirements for portable sealed secondary cells, and for batteries made from them, for use in portable applications –
Part 2: Lithium systems**

Report Number.....: S03A22060710L00301

Date of issue.....: 2022-07-08

Total number of pages.....: 30

Tested by (name + signature).....: JOJO.Tan

JOJO.Tan

Reviewed by (name + signature).....: Regen Hu

Regen.Hu

Approved by(name + signature).....: Rod Liu

Rod Liu

Testing Laboratory Name: Guangdong ESTL Technology Co., Ltd.

Address: Room 101, 201-208, Unit 1, Building 1, No. 9 Headquarters 2nd Road, Songshan Lake Park, Dongguan, Guangdong, China.

Applicant's name.....: Dongguan Linuo industrial Co., Ltd

Address.....: Third Floor, 7 East Second Street, Wusha Xingfa South Road, Chang'an Town, Dongguan City

Test specification:

Standard.....: IEC 62133-2:2017, IEC 62133-2:2017/AMD1:2021

EN 62133-2:2017, EN 62133-2:2017/A1:2021

Test item description.....: Lithium-ion Battery

Trade Mark.....: N/A

Manufacturer.....: Same as a applicant

Address.....: Same as a applicant

Factory.....: Same as a applicant

Address.....: Same as a applicant

Model/Type reference.....: 18650

Ratings.....: 7.4V, 2000mAh, 14.8Wh



List of Attachments (including a total number of pages in each attachment): N/A

Summary of testing:

The unit is charging the empty cell and discharging the full charged cell according to the rating.

Note:

Charging procedures for test purposes:

- (1) Unless otherwise stated, the charging procedure for test purposes is carried out in an ambient temperature of 20±5°C, using the method declared by the manufacturer. Prior to charging, the battery/cell shall have been discharged at 20±5°C at a constant current of 0.2 It A down to a specified final voltage.
- (2) After stabilization for 1 and 4 hours respectively at ambient temperature of highest test temperature 45°C and lowest test temperature 0°C.

Tests performed (test clause and name of test):

Test items:

- cl.7.2.1 Continuous charging at constant voltage (cells);
- cl.7.2.2 Case stress at high ambient temperature (battery);
- cl.7.3.1 External short-circuit (cell);
- cl.7.3.2 External short-circuit (battery);
- cl.7.3.3 Free fall (cell and battery);
- cl.7.3.4 Thermal abuse (cells);
- cl.7.3.5 Crush (cells);
- cl.7.3.6 Over-charging of battery;
- cl.7.3.7 Forced discharge (cells);
- cl.7.3.8 Mechanical tests (batteries);
 - 7.3.8.1 Vibration
 - 7.3.8.2 Mechanical shock
- cl.7.3.9 Forced internal short-circuit (cells).

Tests are made with the number of cells and batteries specified in IEC 62133-2:2017, IEC 62133-2:2017/AMD1:2021 Table 1.

Testing location:

Guangdong ESTL Technology Co., Ltd.
Room 101, 201-208, Unit 1, Building 1, No. 9
Headquarters 2nd Road, Songshan Lake Park,
Dongguan, Guangdong, China.

Summary of compliance with National Differences (List of countries addressed):N/A

The product fulfils the requirements of EN62133-2: 2017, EN 62133-2:2017/A1:2021



Copy of marking plate:

The artwork below may be only a draft. The use of certification marks on a product must be authorized by the respective NCBs that own these marks.

18650 2ICR19/66
7.4V 2000mAh 14.8Wh
Lithium-ion Battery
YYMM
Dongguan Linuo industrial Co., Ltd

Remark: "YY" means to years; "MM" means to months.

draft report



Test item particulars : N/A
Classification of installation and use : To be defined in final product
Supply connection : DC Connector
Recommend charging method declared by the manufacturer : CC/CV
Discharge current (0,2 I_t A) : 400mA
Maximum discharging current : 10A
Specified final voltage : 5.5V (Battery), 2.75V (Cell)
Recommend of charging limit for lithium system
Upper limit charging voltage per cell : 4.2V
Maximum charging current : 2A
Charging temperature upper limit : 45°C
Charging temperature lower limit : 0°C
Polymer cell electrolyte type : <input type="checkbox"/> gel polymer..... <input type="checkbox"/> solid polymer <input checked="" type="checkbox"/> N/A
Possible test case verdicts:
- test case does not apply to the test object..... : N/A (Not Applicable)
- test object does meet the requirement..... : P (Pass)
- test object does not meet the requirement..... : F (Fail)
Testing :
Date of receipt of test item : 2022-06-21
Date (s) of performance of tests : 2022-06-22 to 2022-06-30
General remarks:
The test results presented in this report relate only to the object tested. This report shall not be reproduced, except in full, without the written approval of the Issuing testing laboratory. "(See Enclosure #)" refers to additional information appended to the report. "(See appended table)" refers to a table appended to the report.
Throughout this report a <input type="checkbox"/> comma / <input checked="" type="checkbox"/> point is used as the decimal separator.



General product information and other remarks:

This battery is constructed with two Li-ion Cell in series (2S1P), and has overcharge, over-discharge, over current and short-circuits proof circuit.

The main features of the battery are shown as below:

Model	Nominal capacity	Nominal voltage	Nominal Charge Current	Nominal Discharge Current	Maximum Charge Current	Maximum Discharge Current	Limited Charge Voltage	Cut-off Voltage
18650	2000mAh	7.4V	1000mA	1000mA	2000mA	10000mA	8.4V	5.5V

The main features of the battery are shown as below:

Model	Upper limit charge voltage	Taper-off current	Lower charge temperature	Upper charge temperature
18650	8.4V	20mA	0°C	45°C

The main features of the cell in the battery are shown as below:

Model	Nominal capacity	Nominal voltage	Nominal Charge Current	Nominal Discharge Current	Maximum Charge Current	Maximum Discharge Current	Limited Charge Voltage	Cut-off Voltage
18650 (Cell)	2000mAh	3.7V	1000mA	1000mA	2000mA	10000mA	4.2V	2.75V

The main features of the cell in the battery are shown as below:

Model	Upper limit charge voltage	Taper-off current	Lower charge temperature	Upper charge temperature
18650 (Cell)	4.2V	20mA	0°C	45°C



Circuit diagram:

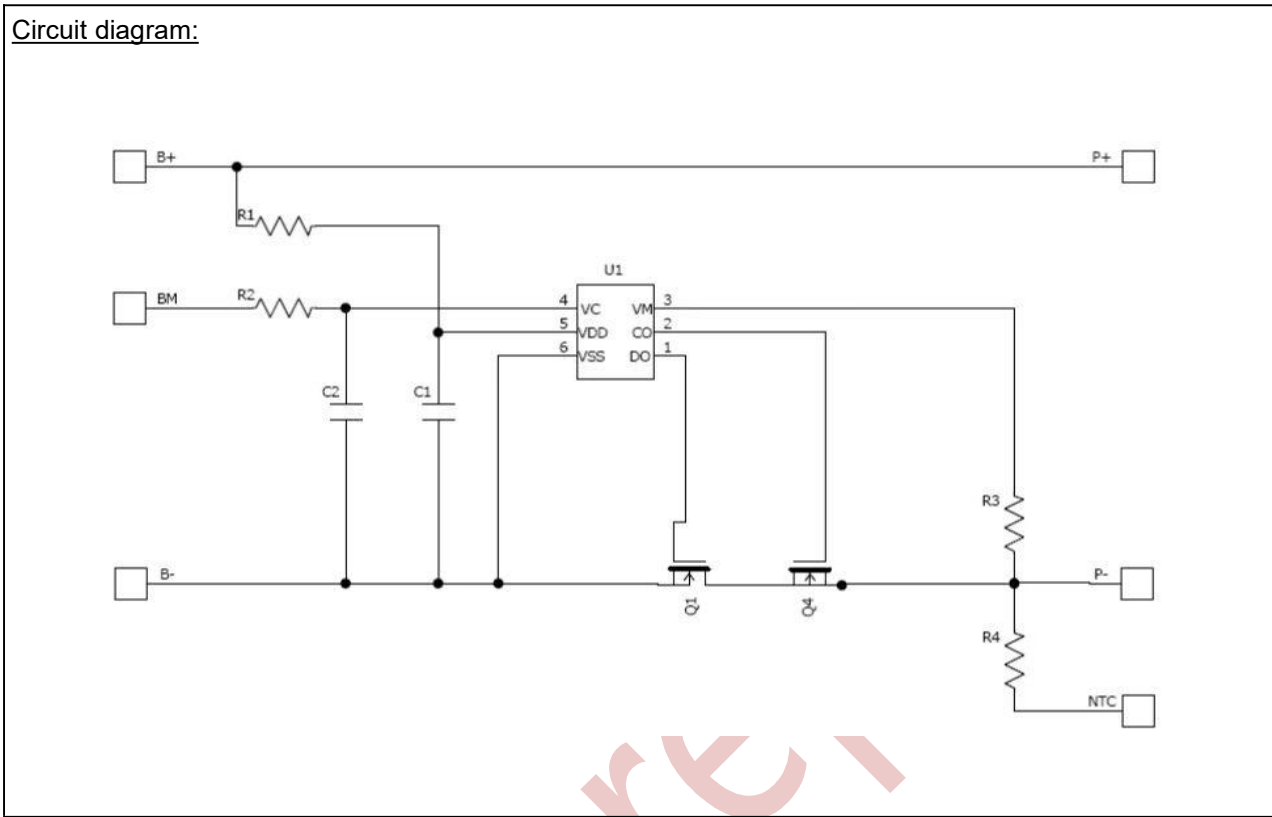

draft

Construction:

Cell

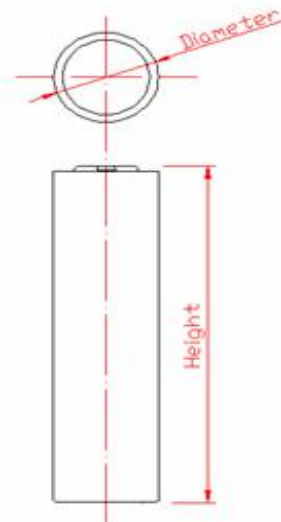
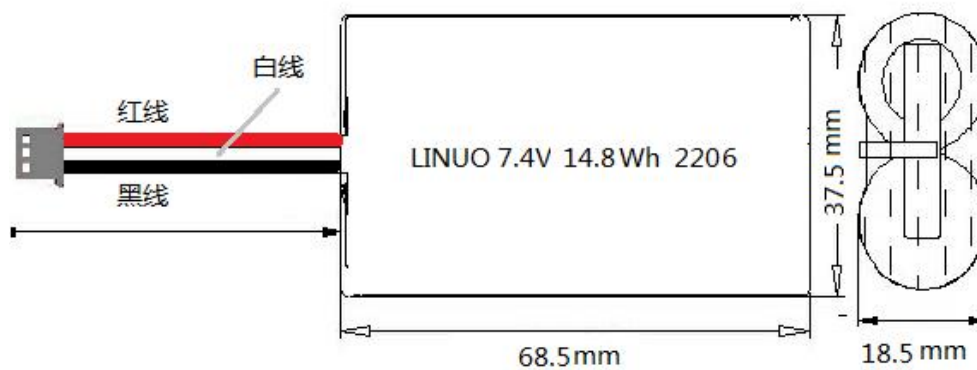

Figure A+

Cell: Max. 18.25mm (D) x Max. 65.50mm (H)

Battery:



Unit: mm



IEC 62133-2			
Clause	Requirement + Test	Result - Remark	Verdict
4	PARAMETER MEASUREMENT TOLERANCES		P
	Parameter measurement tolerances		P
5	GENERAL SAFETY CONSIDERATIONS		P
5.1	General		P
	Cells and batteries so designed and constructed that they are safe under conditions of both intended use and reasonably foreseeable misuse		P
5.2	Insulation and wiring		P
	The insulation resistance between the positive terminal and externally exposed metal surfaces of the battery (excluding electrical contact surfaces) is not less than 5 MΩ	Not metal surfaces exists.	N/A
	Insulation resistance (MΩ)..... :		—
	Internal wiring and insulation are sufficient to withstand maximum anticipated current, voltage and temperature requirements		P
	Orientation of wiring maintains adequate clearance and creepage distances between conductors		P
	Mechanical integrity of internal connections accommodates reasonably foreseeable misuse		P
5.3	Venting		P
	Battery cases and cells incorporate a pressure relief mechanism or are constructed so that they relieve excessive internal pressure at a value and rate that will preclude rupture, explosion and self-ignition	Venting mechanism exists on the Top side of the cylindrical cell	P
	Encapsulation used to support cells within an outer casing does not cause the battery to overheat during normal operation nor inhibit pressure relief		N/A
5.4	Temperature, voltage and current management		P
	Batteries are designed such that abnormal temperature rise conditions are prevented	Overcharge, over discharge, over current and short-circuit proof circuit used in this battery. See tests of clause 7.	P
	Batteries are designed to be within temperature, voltage and current limits specified by the cell manufacturer		P



IEC 62133-2			
Clause	Requirement + Test	Result - Remark	Verdict
	Batteries are provided with specifications and charging instructions for equipment manufacturers so that specified chargers are designed to maintain charging within the temperature, voltage and current limits specified	The charging limits specified in manufacturer's specifications.	P
5.5	Terminal contacts		P
	The size and shape of the terminal contacts ensure that they can carry the maximum anticipated current		P
	External terminal contact surfaces are formed from conductive materials with good mechanical strength and corrosion resistance		P
	Terminal contacts are arranged to minimize the risk of short-circuit		P
5.6	Assembly of cells into batteries		P
5.6.1	General		P
	Each battery have an independent control and protection for current, voltage, temperature and any other parameter required for safety and to maintain the cells within their operating region		P
	This protection may be provided external to the battery such as within the charger or the end devices	Protection circuit within the battery	N/A
	If protection is external to the battery, the manufacturer of the battery provide this safety relevant information to the external device manufacturer for implementation		N/A
	If there is more than one battery housed in a single battery case, each battery have protective circuitry that can maintain the cells within their operating regions		N/A
	Manufacturers of cells specify current, voltage and temperature limits so that the battery manufacturer/designer may ensure proper design and assembly	Current, voltage and temperature limits specified by cell manufacturer.	P
	Batteries that are designed for the selective discharge of a portion of their series connected cells incorporate circuitry to prevent operation of cells outside the limits specified by the cell manufacturer	Battery without selective discharge function.	N/A



IEC 62133-2			
Clause	Requirement + Test	Result - Remark	Verdict
	Protective circuit components added as appropriate and consideration given to the end-device application		P
	The manufacturer of the battery provide a safety analysis of the battery safety circuitry with a test report including a fault analysis of the protection circuit under both charging and discharging conditions confirming the compliance		P
5.6.2	Design recommendation		P
	For the battery consisting of a single cell or a single cellblock, it is recommended that the charging voltage of the cell does not exceed the upper limit of the charging voltage specified in Table 2		N/A
	For the battery consisting of series-connected plural single cells or series-connected plural cellblocks, it is recommended that the voltages of any one of the single cells or single cellblocks does not exceed the upper limit of the charging voltage, specified in Table 2, by monitoring the voltage of every single cell or the single cellblocks		P
	For the battery consisting of series-connected plural single cells or series-connected plural cellblocks, it is recommended that charging is stopped when the upper limit of the charging voltage is exceeded for any one of the single cells or single cellblocks by measuring the voltage of every single cell or the single cellblocks		P
	For batteries consisting of series-connected cells or cell blocks, nominal charge voltage not be counted as an overcharge protection		P
	For batteries consisting of series-connected cells or cell blocks, cells have closely matched capacities, be of the same design, be of the same chemistry and be from the same manufacturer		P
	It is recommended that the cells and cell blocks not discharged beyond the cell manufacturer's specified final voltage		P
	For batteries consisting of series-connected cells or cell blocks, cell balancing circuitry incorporated into the battery management system		N/A



IEC 62133-2			
Clause	Requirement + Test	Result - Remark	Verdict
5.6.3	Mechanical protection for cells and components of batteries		N/A
	Mechanical protection for cells, cell connections and control circuits within the battery provided to prevent damage as a result of intended use and reasonably foreseeable misuse		N/A
	The mechanical protection can be provided by the battery case or it can be provided by the end product enclosure for those batteries intended for building into an end product		N/A
	The battery case and compartments housing cells designed to accommodate cell dimensional tolerances during charging and discharging as recommended by the cell manufacturer		N/A
	For batteries intended for building into a portable end product, testing with the battery installed within the end product considered when conducting mechanical tests		N/A
5.7	Quality plan		P
	The manufacturer prepares and implements a quality plan that defines procedures for the inspection of materials, components, cells and batteries and which covers the whole process of producing each type of cell or battery	Complied. ISO 9001: 2015 certificate provided.	P
5.8	Battery safety components		N/A
6	TYPE TEST AND SAMPLE SIZE		P
	Tests are made with the number of cells or batteries specified in Table 1 using cells or batteries that are not more than six months old		P
	Coin cells with resistance $\leq 3 \Omega$ (measured according annex D) are tested according table 1	Not coin cells	N/A
	Unless otherwise specified, tests are carried out in an ambient temperature of $20 \text{ }^\circ\text{C} \pm 5 \text{ }^\circ\text{C}$		P
	The safety analysis of 5.6.1 identify those components of the protection circuit that are critical for short-circuit, overcharge and overdischarge protection		P



IEC 62133-2			
Clause	Requirement + Test	Result - Remark	Verdict
	When conducting the short-circuit test, consideration given to the simulation of any single fault condition that is likely to occur in the protecting circuit that would affect the short-circuit test		P
7	SPECIFIC REQUIREMENTS AND TESTS		P
7.1	Charging procedure for test purposes		P
7.1.1	First procedure		P
	This charging procedure applies to subclauses other than those specified in 7.1.2		P
	Unless otherwise stated in this document, the charging procedure for test purposes is carried out in an ambient temperature of 20 °C ± 5 °C, using the method declared by the manufacturer		P
	Prior to charging, the battery have been discharged at 20 °C ± 5 °C at a constant current of 0,2 It A down to a specified final voltage		P
7.1.2	Second procedure		P
	This charging procedure applies only to 7.3.1, 7.3.4, 7.3.5, and 7.3.9		P
	After stabilization for 1 h and 4 h, respectively, at ambient temperature of highest test temperature and lowest test temperature, as specified in Table 2, cells are charged by using the upper limit charging voltage and maximum charging current, until the charging current is reduced to 0,05 It A, using a constant voltage charging method	Charge temperature 0-45°C declared.	P
7.2	Intended use		P
7.2.1	Continuous charging at constant voltage (cells)	Tests Complied.	P
	Fully charged cells are subjected for 7 days to a charge using the charging method for current and standard voltage specified by the cell manufacturer		P
	Results: No fire. No explosion. No leakage.....: (See appended table 7.2.1)		P
7.2.2	Case stress at high ambient temperature (battery)	Tested complied.	P
	Oven temperature (°C).....: 70°C ± 2°C		—



IEC 62133-2			
Clause	Requirement + Test	Result - Remark	Verdict
	Results: No physical distortion of the battery case resulting in exposure of internal protective components and cells	No physical distortion of the battery case	P
7.3	Reasonably foreseeable misuse	See below	P
7.3.1	External short-circuit (cell)	Tests Complied.	P
	The cells were tested until one of the following occurred:		P
	- 24 hours elapsed; or		N/A
	- The case temperature declined by 20 % of the maximum temperature rise		P
	Results: No fire. No explosion..... :	(See appended table 7.3.1)	P
7.3.2	External short-circuit (battery)	Tested complied.	P
	The batteries were tested until one of the following occurred:		P
	- 24 hours elapsed; or		N/A
	- The case temperature declined by 20 % of the maximum temperature rise		P
	In case of rapid decline in short circuit current, the battery pack remained on test for an additional one hour after the current reached a low end steady state condition		P
	A single fault in the discharge protection circuit conducted on one to four (depending upon the protection circuit) of the five samples before conducting the short-circuit test		P
	A single fault applies to protective component parts such as MOSFET, fuse, thermostat or positive temperature coefficient (PTC) thermistor	Single fault applies on MOSFET (Q1)	P
	Results: No fire. No explosion..... :	(See appended table 7.3.2)	P
7.3.3	Free fall	Tests Complied.	P
	Results: No fire. No explosion	No fire. No explosion	P
7.3.4	Thermal abuse (cells)	Tests Complied.	P
	Oven temperature (°C)..... :	130°C ± 2°C	—
	Results: No fire. No explosion	No fire. No explosion	P



IEC 62133-2			
Clause	Requirement + Test	Result - Remark	Verdict
7.3.5	Crush (cells)	Tests Complied.	P
	The crushing force was released upon:		P
	- The maximum force of 13 kN ± 0,78 kN has been applied; or		P
	- An abrupt voltage drop of one-third of the original voltage has been obtained		N/A
	Results: No fire. No explosion..... :	(See appended table 7.3.5)	P
7.3.6	Over-charging of battery	Tests Complied.	P
	The supply voltage which is:		P
	- 1,4 times the upper limit charging voltage presented in Table A.1 (but not to exceed 6,0 V) for single cell/cell block batteries or		N/A
	- 1,2 times the upper limit charging voltage presented in Table A.1 per cell for series connected multi-cell batteries, and		P
	- Sufficient to maintain a current of 2,0 It A throughout the duration of the test or until the supply voltage is reached		P
	Test was continued until the temperature of the outer casing:		P
	- Reached steady state conditions (less than 10 °C change in 30-minute period); or		N/A
	- Returned to ambient		P
	Results: no fire, no explosion..... :	(See appended table 7.3.6)	P
7.3.7	Forced discharge (cells)	Tests Complied.	P
	Discharge a single cell to the lower limit discharge voltage specified by the cell manufacturer		P
	The discharged cell is then subjected to a forced discharge at 1 It A to the negative value of the upper limit charging voltage		P
	- The discharge voltage reaches the negative value of upper limit charging voltage within the testing duration. The voltage is maintained at the negative value of the upper limit charging voltage by reducing the current for the remainder of the testing duration		N/A



IEC 62133-2			
Clause	Requirement + Test	Result - Remark	Verdict
	- The discharge voltage does not reach the negative value of upper limit charging voltage within the testing duration. The test is terminated at the end of the testing duration		P
7.3.8	Mechanical tests (batteries)		P
7.3.8.1	Vibration	Tests Complied.	P
	Results: no fire, no explosion, no rupture, no leakage or venting.....:	(See appended table 7.3.8.1)	P
7.3.8.2	Mechanical shock	Tests Complied.	P
	Results: no leakage, no venting, no rupture, no explosion and no fire.....:	(See appended table 7.3.8.2)	P
7.3.9	Design evaluation – Forced internal short-circuit (cells)	Tests Complied.	P
	The cells complied with national requirement for.....:	France, Japan, Korea, Switzerland	—
	The pressing was stopped upon:		P
	- A voltage drop of 50 mV has been detected; or		N/A
	- The pressing force of 800 N (cylindrical cells) or 400 N (prismatic cells) has been reached	800N for cylindrical cells	P
	Results: no fire.....:	(See appended table 7.3.9)	P



IEC 62133-2			
Clause	Requirement + Test	Result - Remark	Verdict
8	INFORMATION FOR SAFETY		P
8.1	General		P
	Manufacturers of secondary cells provides information about current, voltage and temperature limits of their products	Information is provided in manufacturer's specification.	P
	Manufacturers of batteries provides information regarding how to minimize and mitigate hazards to equipment manufacturers or end-users	Information is provided in manufacturer's specification.	P
	Systems analyses are performed by device manufacturers to ensure that a particular battery design prevents hazards from occurring during use of a product		N/A
	As appropriate, any information relating to hazard avoidance resulting from a system analysis is provided to the end user		N/A
8.2	Small cell and battery safety information	Not small cell and battery.	N/A
	The following warning language is to be provided with the information packaged with the small cells and batteries or equipment using them:		N/A
	- Keep small cells and batteries which are considered swallowable out of the reach of children		N/A
	- Swallowing may lead to burns, perforation of soft tissue, and death. Severe burns can occur within 2 h of ingestion		N/A
	- In case of ingestion of a cell or battery, seek medical assistance promptly		N/A
9	MARKING		P
9.1	Cell marking		P
	Cells are marked as specified in IEC 61960, except coin cells		N/A
	Coin cells whose external surface area is too small to accommodate the markings on the cells show the designation and polarity		N/A



IEC 62133-2			
Clause	Requirement + Test	Result - Remark	Verdict
	By agreement between the cell manufacturer and the battery and/or end product manufacturer, component cells used in the manufacture of a battery need not be marked		P
9.2	Battery marking		P
	Batteries are marked as specified in IEC 61960, except for coin batteries		P
	Coin batteries whose external surface area is too small to accommodate the markings on the batteries show the designation and polarity	Not coin batteries.	N/A
	Batteries are marked with an appropriate caution statement		P
	- Terminals have clear polarity marking on the external surface of the battery, or		N/A
	- Not be marked with polarity markings if the design of the external connector prevents reverse polarity connections		P
9.3	Caution for ingestion of small cells and batteries	Not small cell and battery.	N/A
	Coin cells and batteries identified as small batteries include a caution statement regarding the hazards of ingestion in accordance with 8.2		N/A
	Small cells and batteries are intended for direct sale in consumer-replaceable applications, caution for ingestion is given on the immediate package		N/A
9.4	Other information		P
	The following information are marked on or supplied with the battery:		P
	- Storage and disposal instructions	Information for storage and disposal instructions mentioned in manufacturer's specifications.	P
	- Recommended charging instructions	Information for recommended charging instructions mentioned in manufacturer's specifications.	P
10	PACKAGING AND TRANSPORT		P



IEC 62133-2			
Clause	Requirement + Test	Result - Remark	Verdict
	Packaging for coin cells are not be small enough to fit within the limits of the ingestion gauge of Figure 3	Not Coin cells.	N/A

ANNEX A	CHARGING AND DISCHARGING RANGE OF SECONDARY LITHIUM ION CELLS FOR SAFE USE		P
A.1	General		P
A.2	Safety of lithium ion secondary battery		P
A.3	Consideration on charging voltage		P
A.3.1	General	Charging voltage is 4.2V.	P
A.3.2	Upper limit charging voltage	4.2V	P
A.3.2.1	General		P
A.3.2.2	Explanation of safety viewpoint		P
A.3.2.3	Safety requirements, when different upper limit charging voltage is applied		P
A.4	Consideration of temperature and charging current		P
A.4.1	General		P
A.4.2	Recommended temperature range	See A.4.2.2	P
A.4.2.1	General		P
A.4.2.2	Safety consideration when a different recommended temperature range is applied	Charging temperature declared by client is: 0-45°C.	P
A.4.3	High temperature range		N/A
A.4.3.1	General		N/A
A.4.3.2	Explanation of safety viewpoint		N/A
A.4.3.3	Safety considerations when specifying charging conditions in the high temperature range		N/A
A.4.3.4	Safety considerations when specifying a new upper limit in the high temperature range		N/A
A.4.4	Low temperature range		P
A.4.4.1	General		P
A.4.4.2	Explanation of safety viewpoint		P



IEC 62133-2			
Clause	Requirement + Test	Result - Remark	Verdict
A.4.4.3	Safety considerations, when specifying charging conditions in the low temperature range		N/A
A.4.4.4	Safety considerations when specifying a new lower limit in the low temperature range		N/A
A.4.5	Scope of the application of charging current		P
A.4.6	Consideration of discharge		P
A.4.6.1	General		P
A.4.6.2	Final discharge voltage and explanation of safety viewpoint		P
A.4.6.3	Discharge current and temperature range		P
A.4.6.4	Scope of application of the discharging current		P
A.5	Sample preparation		P
A.5.1	General		P
A.5.2	Insertion procedure for nickel particle to generate internal short		P
A.5.3	Disassembly of charged cell		P
A.5.4	Shape of nickel particle		P
A.5.5	Insertion of nickel particle in cylindrical cell		P
A.5.5.1	Insertion of nickel particle in winding core		P
A.5.5.2	Marking the position of the nickel particle on both ends of the winding core of the separator		P
A.5.6	Insertion of nickel particle in prismatic cell		N/A
A.6	Experimental procedure of the forced internal short-circuit test		P
A.6.1	Material and tools for preparation of nickel particle		P
A.6.2	Example of a nickel particle preparation procedure		P
A.6.3	Positioning (or placement) of a nickel particle		P
A.6.4	Damaged separator precaution		P
A.6.5	Caution for rewinding separator and electrode		P
A.6.6	Insulation film for preventing short-circuit		P
A.6.7	Caution when disassembling a cell		P
A.6.8	Protective equipment for safety		P



IEC 62133-2			
Clause	Requirement + Test	Result - Remark	Verdict
A.6.9	Caution in the case of fire during disassembling		P
A.6.10	Caution for the disassembling process and pressing the electrode core		P
A.6.11	Recommended specifications for the pressing device		P
ANNEX B	RECOMMENDATIONS TO EQUIPMENT MANUFACTURERS AND BATTERY ASSEMBLERS		P
ANNEX C	RECOMMENDATIONS TO THE END-USERS		N/A
ANNEX D	MEASUREMENT OF THE INTERNAL AC RESISTANCE FOR COIN CELLS		N/A
D.1	General		N/A
D.2	Method		N/A
	A sample size of three coin cells is required for this measurement		N/A
	Coin cells with an internal resistance greater than 3 Ω require no further testing.....	(See appended table D.2)	N/A
	Coin cells with an internal resistance less than or equal to 3 Ω are subjected to the testing according to Clause 6 and Table 1		N/A
ANNEX E	PACKAGING AND TRANSPORT		P
ANNEX F	COMPONENT STANDARDS REFERENCES		N/A



IEC 62133-2			
Clause	Requirement + Test	Result - Remark	Verdict

TABLE: Critical components information					P
Object/part no.	Manufacturer/ trademark	Type/model	Technical data	Standard	Mark(s) of conformity ¹⁾
Cell	Dongguan Linuo industrial Co., Ltd	18650	3.7V, 2000mAh	IEC 62133-2:2017, IEC 62133-2:2017/AM D1:2021	Tested with appliance
-Positive electrode	Shenzhen Fulaishun Electronic Material Co.,Ltd	MT310	LiCoO ₂	--	--
-Negative electrode	Hubei Zhongyi Technology Co.. Ltd.	Q20	Graphite	--	--
-Separator	Wuhan Huiqiang New Energy Material Technology Co., Ltd.	12um	PP, 12um(T), Shutdown temperature: 130°C	--	--
-Electrolyte	Henan Fainlet New Energy Technology Co., Ltd.	SW-3195P	LiPF ₆ +EC+EMC+DMC+PC+VC	--	--
PCB	Interchangeable	Interchangeable	V-0, 130°C	UL 796	UL approved
Charging and discharging Lead wire	DONGGUAN DENGSHI MACHINE & ELECTRIC CO LTD	3239	20AWG, 150°C, 3KV	UL 758	UL E360170
Charging and discharging Lead wire	Interchangeable	Interchangeable	20AWG, 150°C, 3KV	UL 758	UL approved
IC (U1)		VA7022E	VDET1: 4.28V±0.025V, VDET2: 2.9V±0.08V	--	Tested with appliance
MOSFET (Q1, Q2, Q3, Q4)		40N02		--	Tested with appliance
Connector				UL 94	UL approved

Supplementary information:

¹⁾ Provided evidence ensures the agreed level of compliance. See OD-2039.



IEC 62133-2			
Clause	Requirement + Test	Result - Remark	Verdict

7.2.1	TABLE: Continuous charging at constant voltage (cells)				P
Sample No.	Recommended charging voltage Vc (Vdc)	Recommended charging current I _{rec} (A)	OCV before test (Vdc)	Results	
C1#	4.2	1	4.182	A	
C2#	4.2	1	4.184	A	
C3#	4.2	1	4.182	A	
C4#	4.2	1	4.183	A	
C5#	4.2	1	4.182	A	
Supplementary information: A - No fire. No explosion. No leakage. B - Fire. C - Explosion. D - Leakage. E - Bulge. F - Others (please explain).					

7.3.1	TABLE: External short circuit (cell)					P
Sample No.	Ambient (°C)	OCV at start of test (Vdc)	Resistance of circuit (mΩ)	Maximum case temperature rise ΔT (K)	Results	
Samples charged at charging temperature upper limit (45°C)						
C6#	55.4	4.185	82	45.2	A, H	
C7#	55.4	4.184	74	49.7	A, H	
C8#	55.4	4.185	79	45.6	A, H	
C9#	55.4	4.184	88	48.1	A, H	
C10#	55.3	4.184	85	52.2	A, H	
Samples charged at charging temperature lower limit (0°C)						
C11#	55.3	4.143	92	53.8	A, H	
C12#	55.4	4.144	77	61.9	A, H	
C13#	55.4	4.145	78	60.6	A, H	
C14#	55.3	4.144	85	45.1	A, H	
C15#	55.3	4.144	96	64.4	A, H	



IEC 62133-2			
Clause	Requirement + Test	Result - Remark	Verdict

Supplementary information:

A - No fire. No explosion.
 B - Fire.
 C - Explosion.
 D - Leakage.
 E - Bulge.
 F - Others (please explain).
 G - The test was completed after 24 h.
 H - The test was completed after the cell casing cooled to 20% of the maximum temperature rise.

7.3.2	TABLE: External short circuit (battery)					P
Sample No.	Ambient T (°C)	OCV before test (Vdc)	Resistance of circuit (mΩ)	Maximum case temperature rise ΔT (K)	Component single fault condition	Results
B4#	56.7	8.37	82	96.4	Q1	A, H
B5#	56.7	8.38	89	96.3	Q1	A, H
B6#	56.6	8.37	74	97.6	Q1	A, H
B7#	56.7	8.37	79	92.1	Q1	A, H
B8#	56.7	8.37	85	0.3	Normal	A, F

Supplementary information:

A - No fire. No explosion.
 B - Fire.
 C - Explosion.
 D - Leakage.
 E - Bulge.
 F - Others (please explain). -rapid decline in short circuit current, the battery pack should remain on test for an additional one hour after the current reaches a low end steady state condition.
 G - The test was completed after 24 h.
 H - The test was completed after the cell casing cooled to 20% of the maximum temperature rise.

7.3.5	TABLE: Crush (cells)			P
Sample No.	OCV before test (Vdc)	OCV at removal of crushing force (Vdc)	Maximum force applied to the cell during crush (kN)	Results
Samples charged at charging temperature upper limit (45°C)				
C29#	4.186	--	12.9	A, G
C30#	4.186	--	12.9	A, G
C31#	4.185	--	12.9	A, G
C32#	4.186	--	12.9	A, G



IEC 62133-2				
Clause	Requirement + Test		Result - Remark	Verdict
C33#	4.184	--	12.9	A, G
Samples charged at charging temperature lower limit (0°C)				
C34#	4.143	--	12.9	A, G
C35#	4.144	--	12.9	A, G
C36#	4.142	--	12.9	A, G
C37#	4.144	--	12.9	A, G
C38#	4.143	--	12.9	A, G
Supplementary information: A - No fire. No explosion. B - Fire. C - Explosion. D - Leakage. E - Bulge. F - Others (please explain). G – Force released after maximum level reached H – Force released after abrupt voltage drop of one-third the original value.				

7.3.6	TABLE: Over-charging of battery			P
Constant charging current (A).....:	4			—
Supply voltage (Vdc).....:	10.08			—
Sample No.	OCV before charging (Vdc)	Total charging time (minute)	Maximum outer case temperature (°C)	Results
B12#	6.324	148	33.9	A
B13#	6.358	148	36.7	A
B14#	6.332	148	34.8	A
B15#	6.341	148	32.8	A
B16#	6.326	148	36.4	A
Supplementary information: A - No fire. No explosion. B - Fire. C - Explosion. D - Leakage. E - Bulge. F - Others (please explain).				



IEC 62133-2			
Clause	Requirement + Test	Result - Remark	Verdict

7.3.7	TABLE: Forced discharge (cells)				P
Sample No.	OCV before application of reverse charge (Vdc)	Measured reverse charge I_t (A)	Lower limit discharge voltage (Vdc)	Results	
C39#	3.233	2	2.75	A, H	
C40#	3.251	2	2.75	A, H	
C41#	3.234	2	2.75	A, H	
C42#	3.236	2	2.75	A, H	
C43#	3.243	2	2.75	A, H	

Supplementary information:

- A - No fire. No explosion.
- B - Fire.
- C - Explosion.
- D - Leakage.
- E - Bulge.
- F - Others (please explain).
- G – The voltage reached negative value of upper limit charging voltage within 90 min.
- H - The voltage did not reach negative value of upper limit charging voltage.

7.3.8.1	TABLE: Vibration					P
Sample No.	OCV before test (Vdc)	OCV after test (Vdc)	Mass before test (g)	Mass after test (g)	Results	
B17#	8.38	8.38	94.454	94.454	A	
B18#	8.38	8.38	94.267	94.267	A	
B19#	8.37	8.37	94.239	94.239	A	

Supplementary information:

- A - No fire. No explosion. No leakage. No venting. No rupture.
- B - Fire.
- C - Explosion.
- D - Leakage.
- E – Venting.
- F – Rupture.
- G - Bulge.
- H - Others (please explain).



IEC 62133-2			
Clause	Requirement + Test	Result - Remark	Verdict

7.3.8.2	TABLE: Mechanical shock					P
Sample No.	OCV before test (Vdc)	OCV after test (Vdc)	Mass before test (g)	Mass after test (g)	Results	
B20#	8.37	8.37	94.512	94.512	A	
B21#	8.37	8.37	94.563	94.563	A	
B22#	8.37	8.37	94.665	94.668	A	

Supplementary information:

A - No fire. No explosion. No leakage. No venting. No rupture.
 B - Fire.
 C - Explosion.
 D - Leakage.
 E - Venting.
 F - Rupture.
 G - Bulge.
 H - Others (please explain).

7.3.9	TABLE: Forced internal short circuit (cells)					P
Sample No.	Chamber ambient T (°C)	OCV before test (Vdc)	Particle location ¹⁾	Maximum applied pressure (N)	Results	
Samples charged at charging temperature upper limit (45°C)						
C44#	45	4.183	1	800	A, H	
C45#	45	4.183	1	800	A, H	
C46#	45	4.182	1	800	A, H	
C47#	45	4.183	1	800	A, H	
C48#	45	4.184	1	800	A, H	
Samples charged at charging temperature lower limit (0°C)						
C49#	0	4.138	1	800	A, H	
C50#	0	4.138	1	800	A, H	
C51#	0	4.137	1	800	A, H	
C52#	0	4.139	1	800	A, H	
C53#	0	4.138	1	800	A, H	



IEC 62133-2			
Clause	Requirement + Test	Result - Remark	Verdict

Supplementary information:

¹⁾ Identify one of the following:

- 1: Nickel particle inserted between positive and negative (active material) coated area.
- 2: Nickel particle inserted between positive aluminium foil and negative active material coated area.

- A – No fire
- B – Fire
- C - Explosion.
- D - Leakage.
- E - Bulge.
- F - Others (please explain).
- G – Test concluded when 50 mV voltage drop occurred prior to reaching force limit
- H – Test concluded when 800 N pressure was reached and 50 mV voltage drop was not achieved
- I – Test was concluded when fire occurred

D.2	TABLE: Internal AC resistance for coin cells				N/A
Sample no.	Ambient T (°C)	Store time (h)	Resistance Rac (Ω)	Results ¹⁾	

Supplementary information:

¹⁾ Coin cells with an internal resistance less than or equal to 3 Ω, see test result on corresponding tables according to Clause 6 and Table 1.

Photos

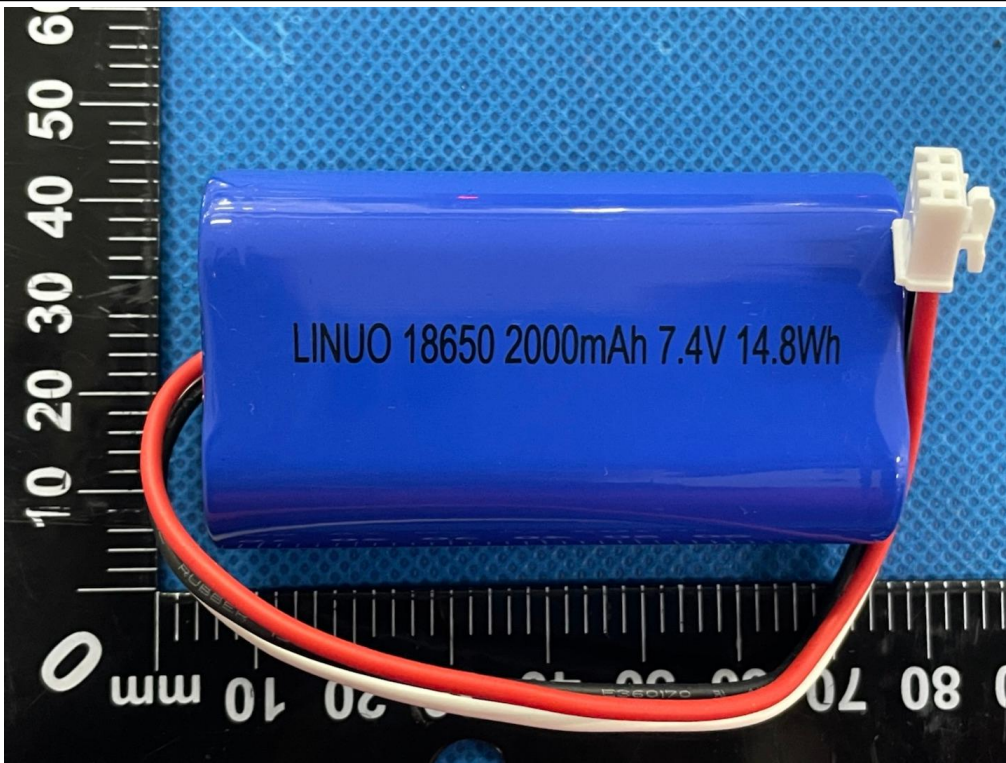

Fig. 1



Fig. 2

Photos

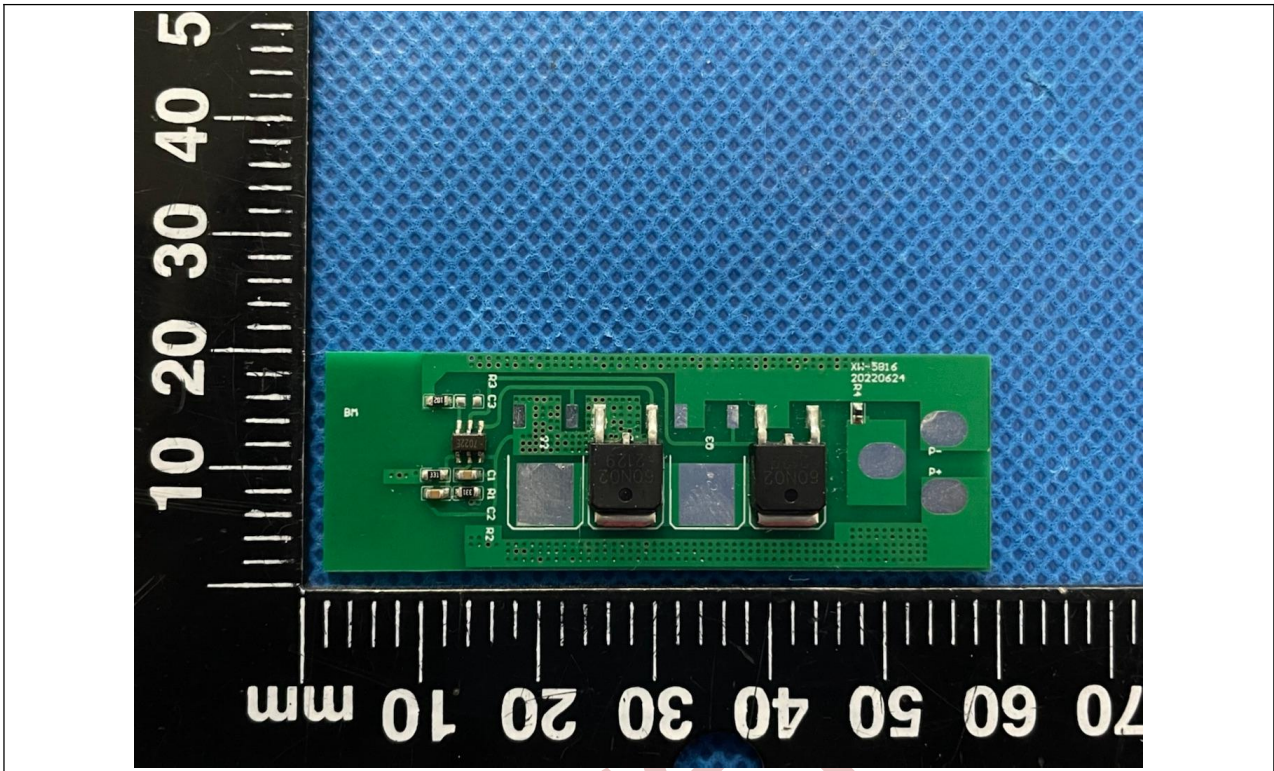

Fig. 3

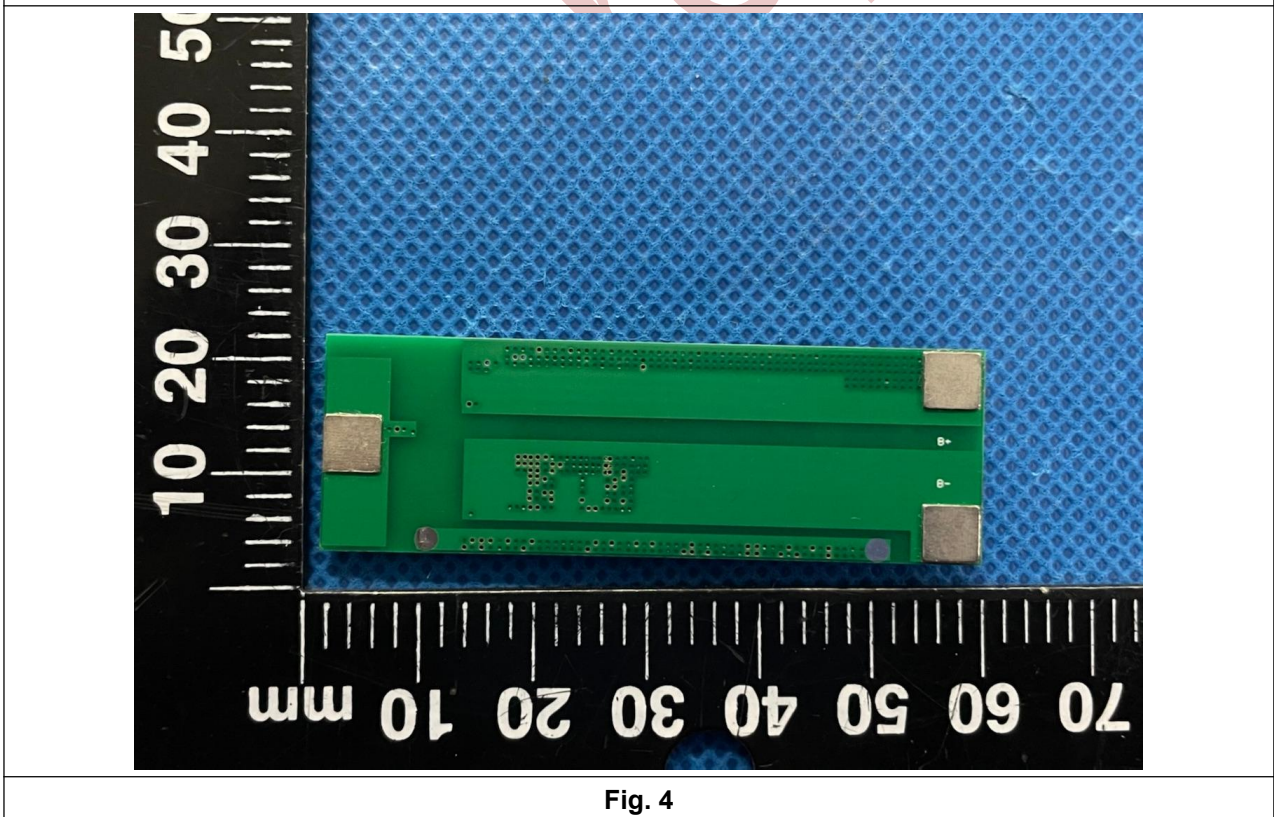

Fig. 4

Photos

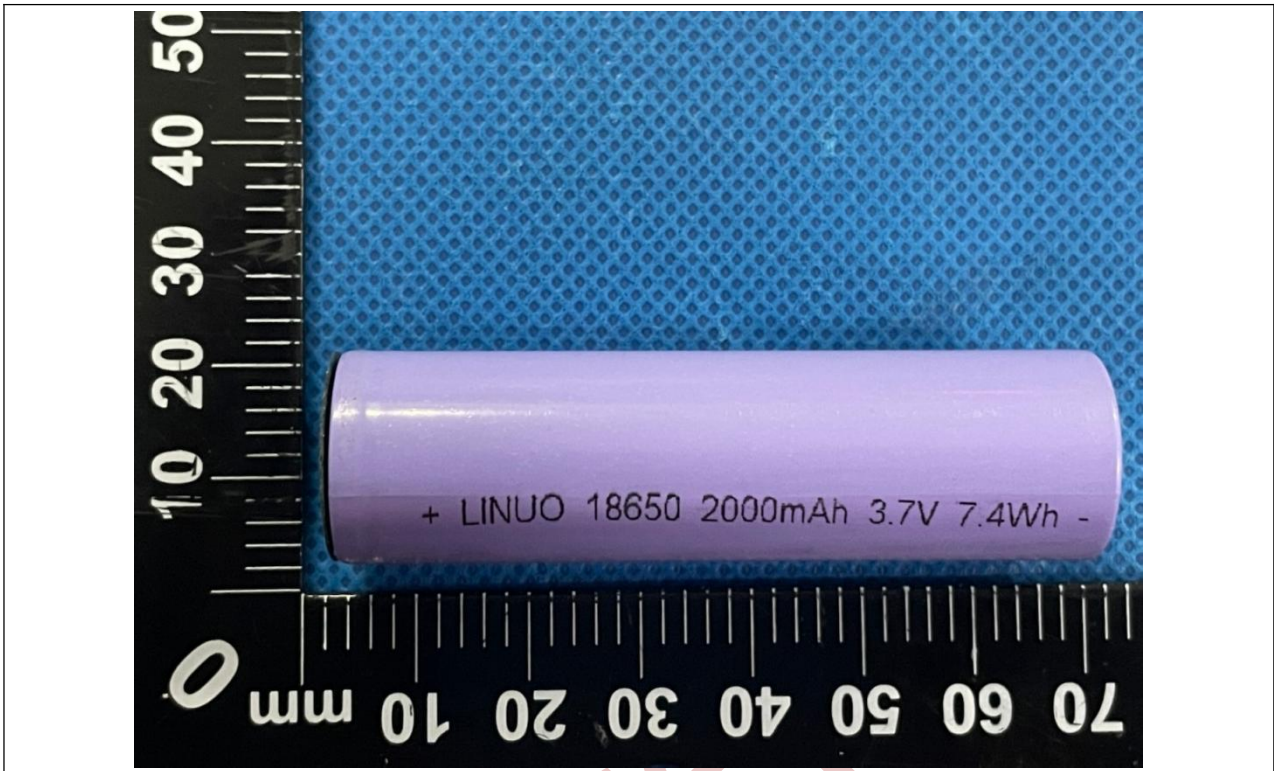

Fig. 5

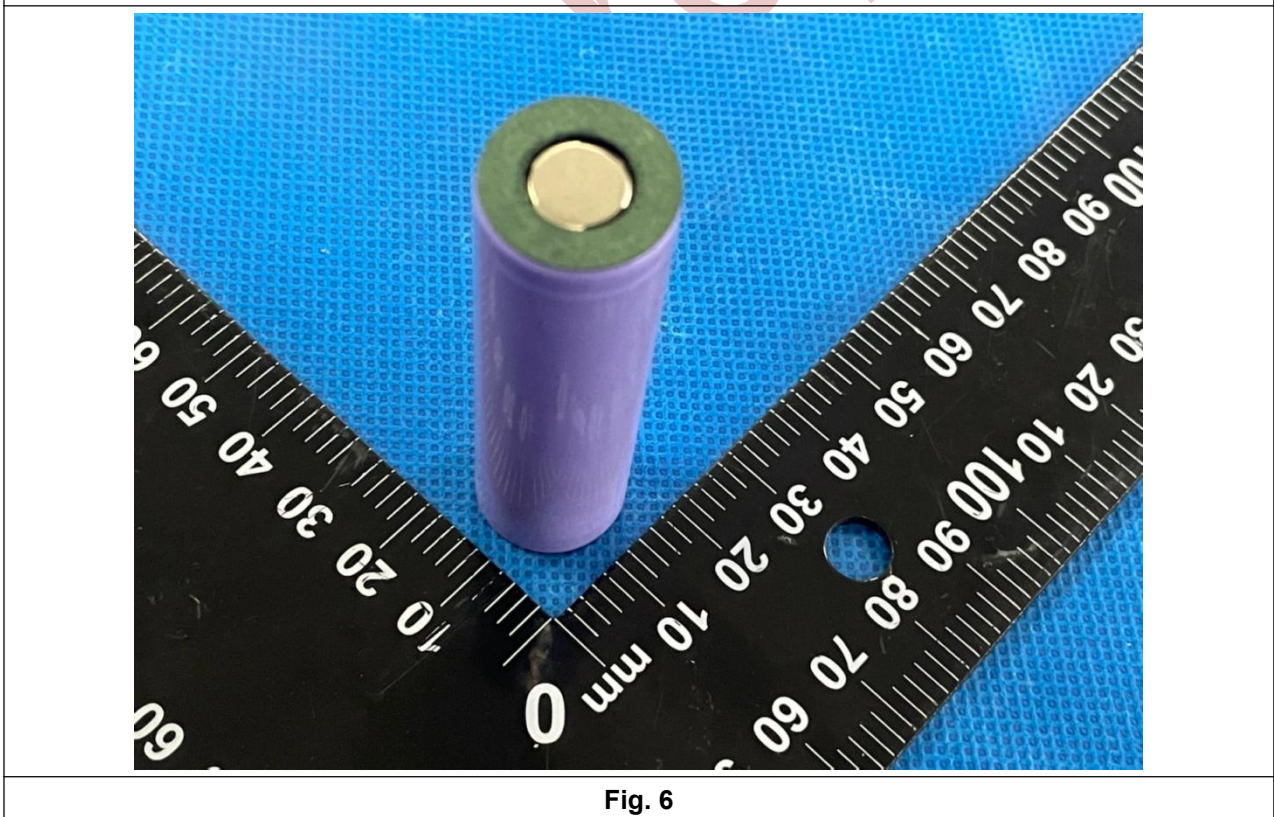

Fig. 6

--- End of Report ---